

# ENGLISH

## Specification of installation

In order to ensure safety use, please notice the following items:

- Read and understand the whole Specification.
- Suitable for the use of 220~240V and 50~60Hz.
- Please wear gloves as installment and avoid rot on the surface of plating.
- Must be installed on the fixed places and be checked annually.
- Please turn off the lighting source by soft cloth as cleaning prohibited to use of rotted detergent.
- Please connect with the local sales service center when there are any abnormality.

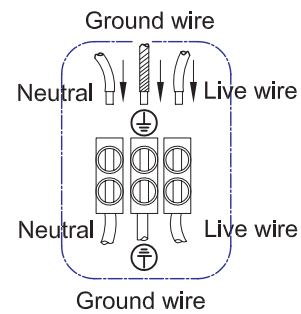
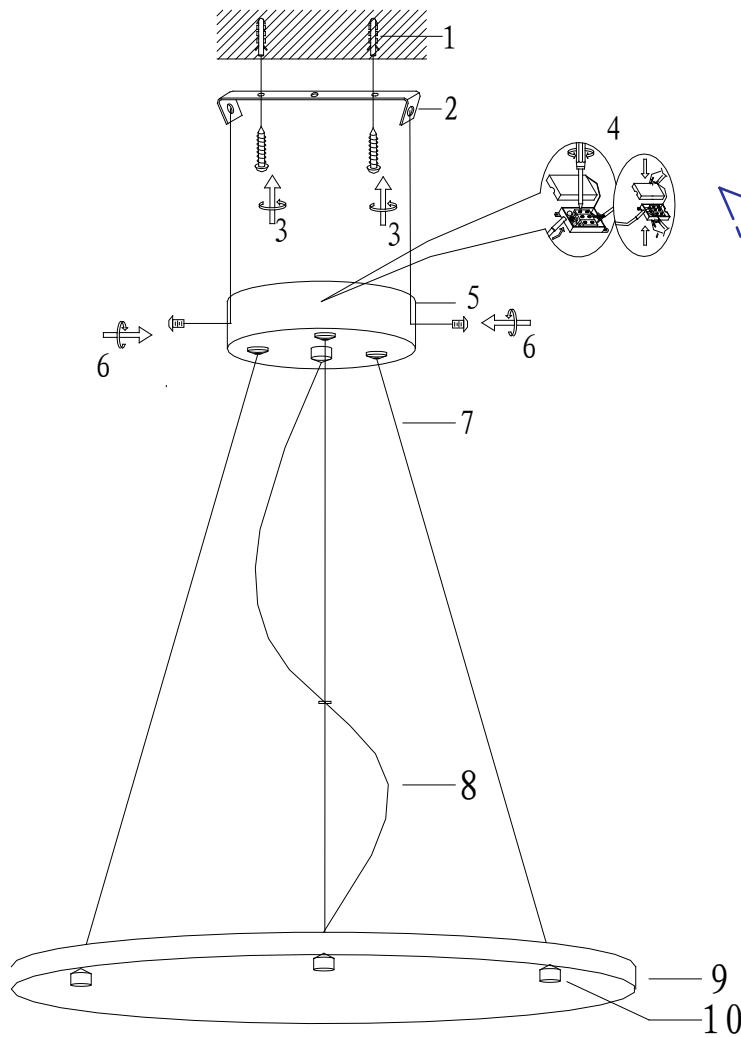

Live wire-Brown  
Neutral-Blue  
Ground wire-Yellow&Green

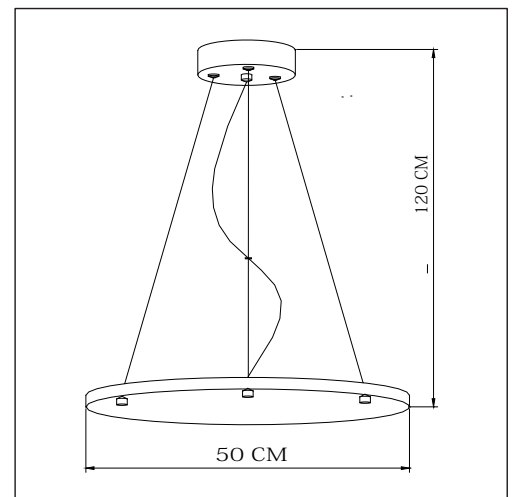

- 1 Wall anchor
- 2 Mounting
- 3 Self-tapping screw
- 4 Terminal
- 5 Canopy
- 6 Screw
- 7 Steel cable
- 8 Wire
- 9 Metal cover
- 10 Screw

Product coding: KIT FOR JEWEL/MIKO 700