

Specification of installation

In order to ensure safety use, please notice the following items:

- . Read and understand the whole specification.
- . Suitable for the use of 220~240v and 50~60Hz.
- . Please wear gloves as installment and avoid rot on the surface of plating.
- . Must be installed on the fixed places and be checked annually.
- . Please turn Off the lightng source by soft cloth as cleaning prohibited to use rotted detergent.
- . Please connect with the local sarvice centhr when there are any abnormality.

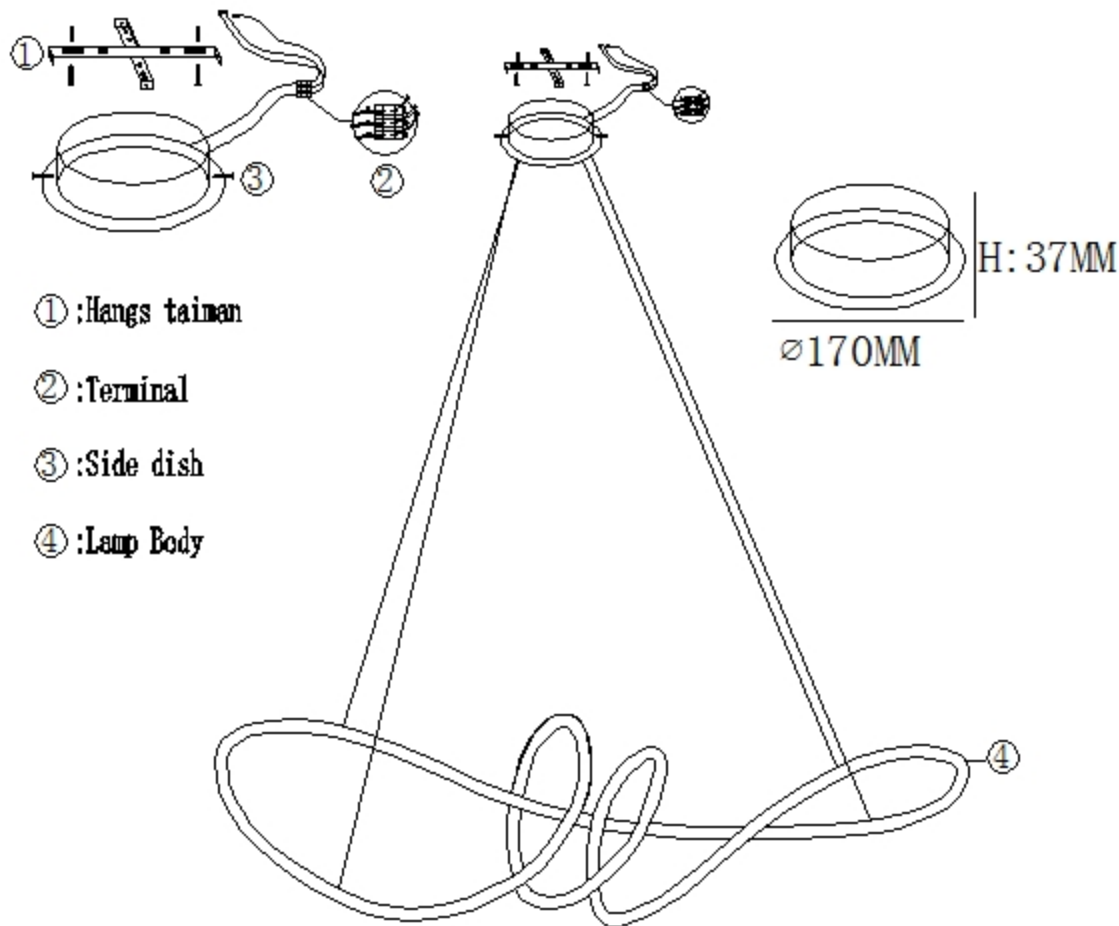

AMIGO SP700 SILVER

FIXTURE SIZE:



E: 230MM

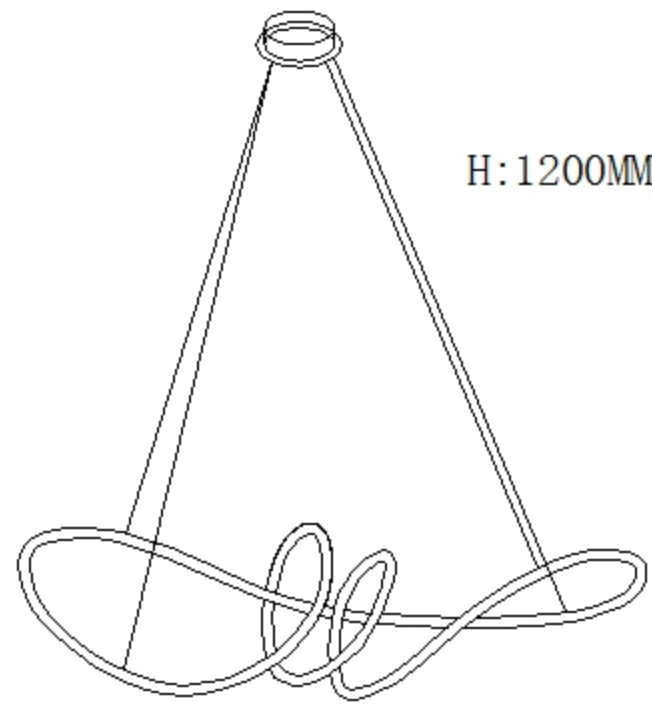

H: 1200MM

W: 720MM